

1-LES TYPES DES PAVÉS ET BLOCS

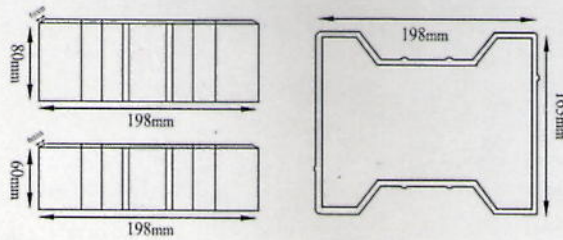

Pavé DOPPIO H

Dimension : 198x163
 Epaisseur : 60mm / 80mm
 Pièce / m² : 36 Pièces
 m² / Palette : 12 / 10
 m² / camion : 216 m² / 160 m²

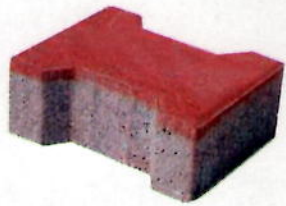
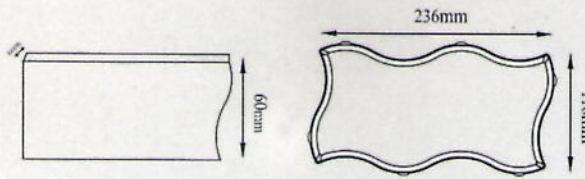

Pavé ONDA

Dimension : 236x116
 Epaisseur : 60mm
 Pièce / m² : 32 Pièces
 m² / Palette : 13,5
 m² / camion : 216 m²

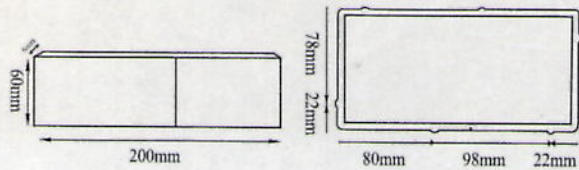

Pavé rectangulaires

Dimension : 200x100
 Epaisseur : 60mm
 Pièce / m² : 30 Pièces
 m² / Palette : 14,4
 m² / camion : 216 m²

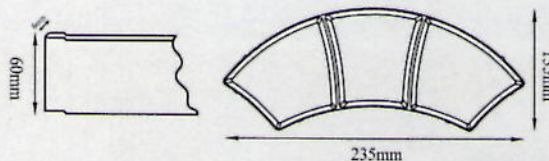

Pavé Arc

Dimension : 235x135
 Epaisseur : 60mm
 Pièce / m² : 34 Pièces
 m² / Palette : 13,5
 m² / camion : 216 m²

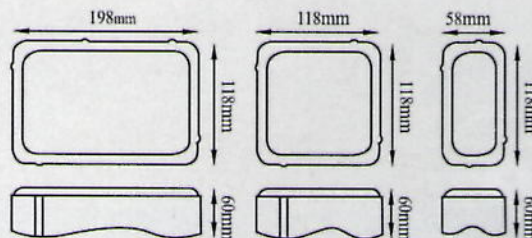
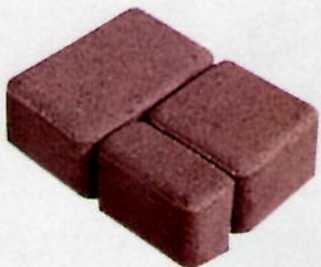

Pavé Rustique

Epaisseur : 60mm
 Pièce / m² : 25 Pièces
 m² / Palette : 14,4
 m² / camion : 216 m²

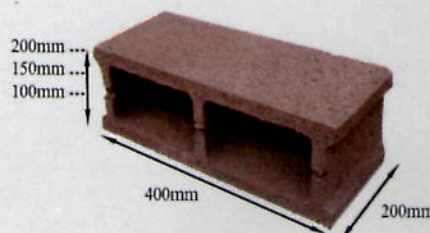
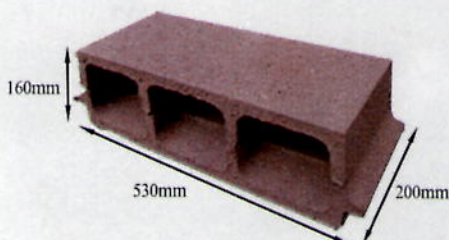

Blocs

P10 Dimension : 100x200x400
 P15 Dimension : 150x200x400
 P20 Dimension : 200x200x400
 H16 Dimension : 160x200x530

LES TYPES DE BORDURES ET CANIVEAUX

Bordure Type A (accotements, Route & Autoroute)

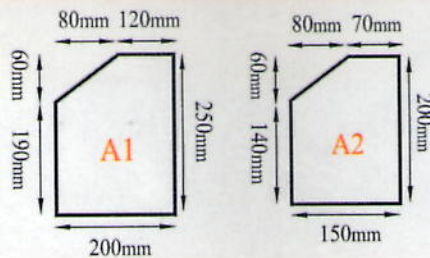

- A1 Dimension :** 200x250x1000
- Pcs / Palette:** 24
- Pcs / camion:** 256 m
- A2 Dimension :** 150x200x1000
- Pcs / Palette:** 24
- Pcs / camion:** 336 m

Bordure Type T (trottoir, Voiries Urbaines)

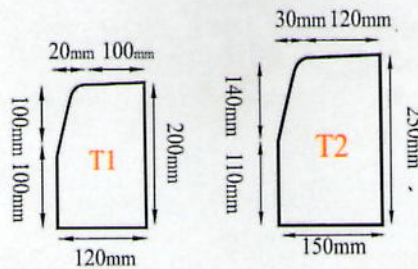
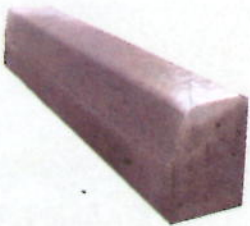

- T1 Dimension :** 120x200x1000
- Pcs/ Palette:** 24
- Pcs / camion:** 336
- T2 Dimension :** 150x250x1000
- Pcs / Palette:** 24
- Pcs / camion:** 336

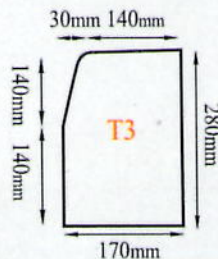

- T3 Dimension :** 170x280x1000
- Pcs / Palette:** 16
- Pcs / camion:** 256

Bordure Type P ((Parking, Jardin, Terrain de sport, Allées, Piétonne)

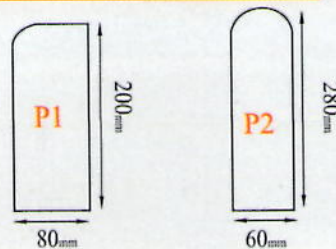

- P1 Dimension :** 80x200x1000
- Pcs / Palette:** 40
- Pcs / camion:** 800
- P2 Dimension :** 60x280x1000
- Pcs / Palette:** 42
- Pcs / camion:** 840

Caniveaux Type CS (Simple Pentes associer avec type A ou T)

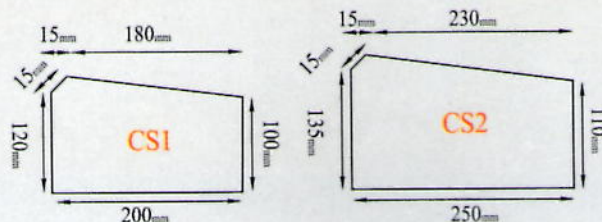

- CS1 Dimension :** 120x200x1000
- Pcs / Palette:** 20
- Pcs / camion:** 320
- CS2 Dimension :** 135x250x1000
- Pcs / Palette:** 20
- Pcs / camion:** 320

Caniveaux Type CC (chaussée (Double Pente))

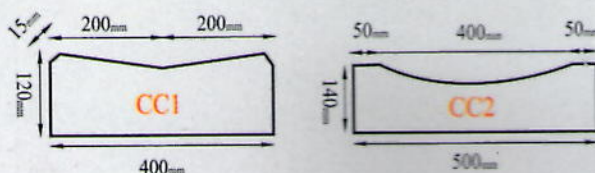

- CC1 Dimension :** 120x400x500
- Pcs / Palette:** 20
- Pcs / camion:** 320 m
- CC2 Dimension :** 140x500x500
- Pcs / Palette:** 20
- Pcs / camion:** 320 m

Tuyaux en Béton Armé Classe: 60A, 90A, 135A

Ø DN int	DF	a	b	c	e	Lr Utile	Lt	Poids (Kg)
300	500	350	80	90	57	2420	2500	408
400	624	450	85	95	70	2415	2500	702
500	760	450	90	100	75	2410	2500	914
600	892	450	90	100	85	2410	2500	1223
800	1140	450	99	105	95	2401	2500	1779
1000	1405	450	99	105	118	2401	2500	2719
1200	1685	450	99	105	135	2401	2500	3763
1500	1804	-	120	120	150	2380	2500	4577
2000	2404	-	130	135	200	2370	2500	7983

Tuyaux en Béton Non Armé

Ø DN int	DF	a	b	c	e	Lr Utile	Lt	Poids (Kg)
300	500	350	80	90	57	2420	2500	400
400	624	450	85	95	70	2415	2500	690
500	760	450	90	100	75	2410	2500	905

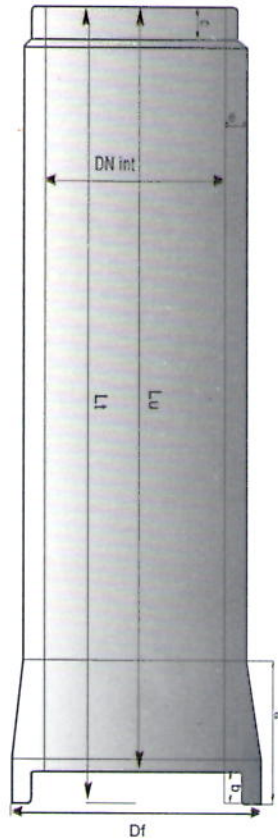

Dalot en béton

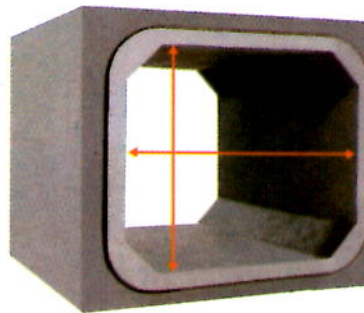
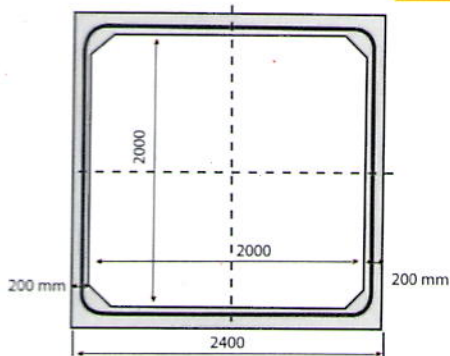

DALOT 2000/2000mm

De : 800 mm / 800 mm
jusqu'au : 2000 mm / 2000 mm

Regard en béton



Schéma fond de regard



Emboitement (Regard - Dalot)

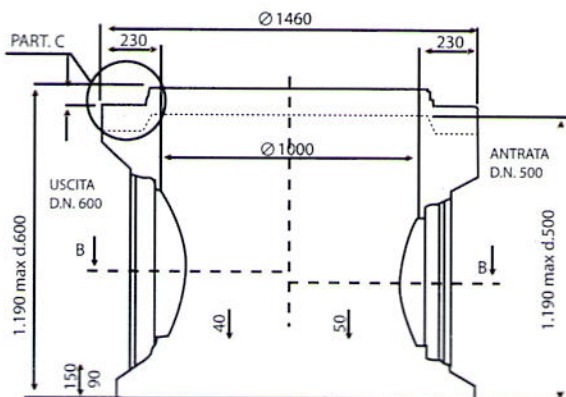
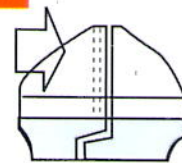
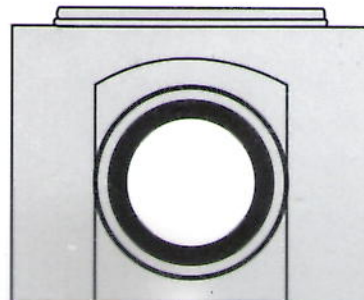

fond de regard



2. Ancre de levage et joint d'étanchéité

Le tuyau **TUBELUX** est dotée d'un joint intégré glissant pour assuré un parfaite étanchéité



Ancre de Levage

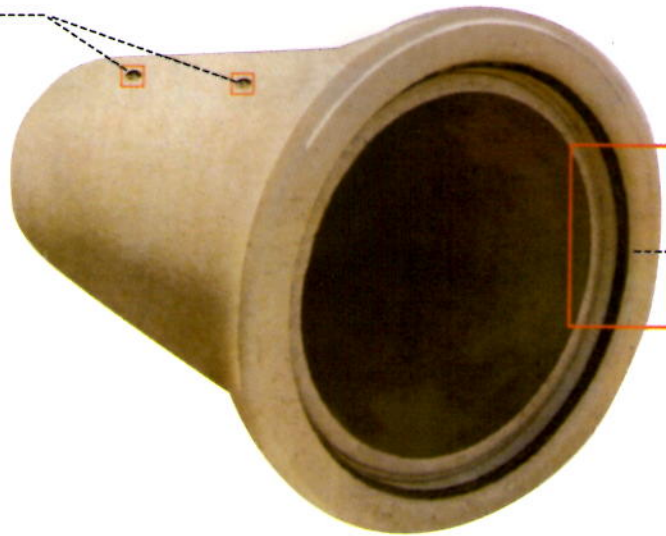

Joint Intégré

Armature de Tuyaux

Les armatures des tuyaux armés **TUBELUX** sont fabriquées par une cageuse automatique, de haute technologie, soudée par impulssion (électrodes).

Nos tuyaux sont fabriqués par des armatures on **une** ou **double nappes** selon la demande des clients.

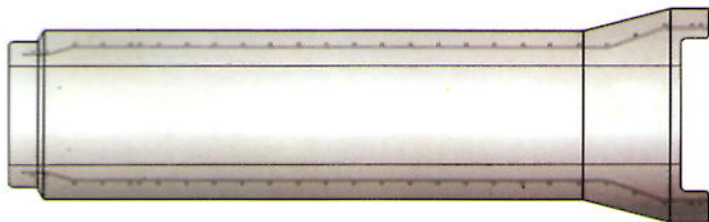

Tuyau avec armature une NAPPE



Tuyau avec armature deux NAPPES

GROUPE BOURENANE

Professionnel de Béton

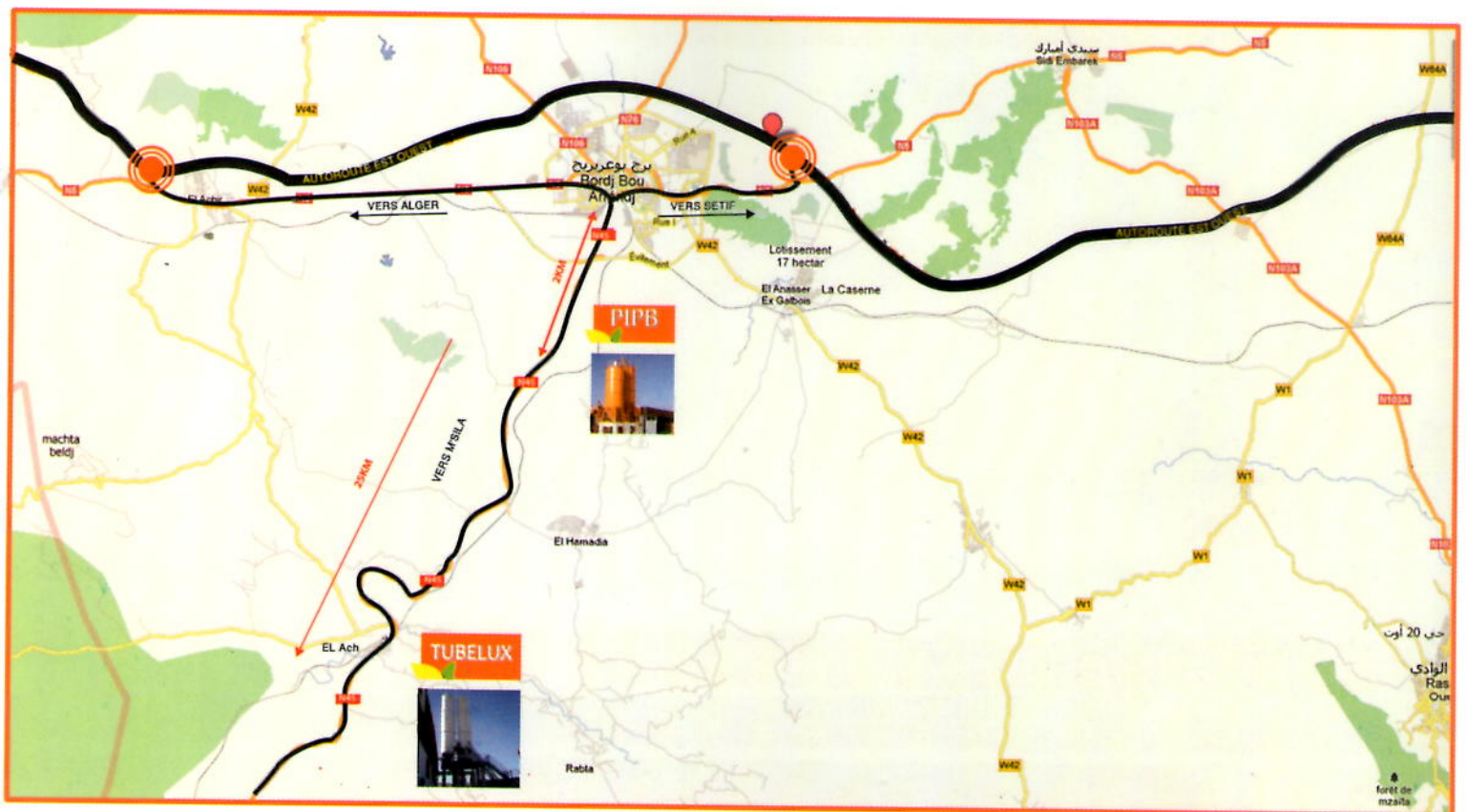

www.groupebourenane.com

E-mail : groupebourenane@hotmail.fr

SARL PIPB

Siège social: D'haissa Route
de M'sila BP431 , B.B.Arréridj
Mob: 0555 048 421 / 0555 048 424
Tel: 030 586 532 , Fax: 030 583 333

SARL TUBELUX

Siège social: Djebel Aissa
EL Euch ,N° 209, B.B.Arréridj
Mob: 0555 044 990 / 0555 048 422
Tel: 030 582 582 , Fax: 030 586 586

ANNEXE

Siège social: Rouiba, Alger
Mob: 0770 590 237 / 0555 048 424
Tel/Fax: 030 586 586